

LINEAR

LIGHTING

ARCHITECTURAL LIGHTING
GENERAL LIGHTING





rasmi

Aluminum linear light

index

Mini size
Aluminum strip light
PAGE01-07

Middle size
Aluminum strip light
PAGE08-10

MAXIMUM size
Aluminum strip light
PAGE11-17

Regional optical
Aluminum strip light
PAGE18-26

WALLWASHER
Aluminum strip light
PAGE27-27

EMBEDDED MINI
Linear light Series
PAGE28-42

CEILING SQUARE SERIES
PAGE43-44

MINI size

Aluminum strip light



RAS-058-M1814

DC24V    **IP54** **CE** 



MODEL NO:RAS-058-M1814

POWER: 14.4W / 1M

Luminous flux: 1580LM/1M

Color temperature: 3000K & 4000K & 6000K

Color rendering index:RA>80

Input voltage: DC 24V

INGRESS PROTECTION:IP54



DIMENSION

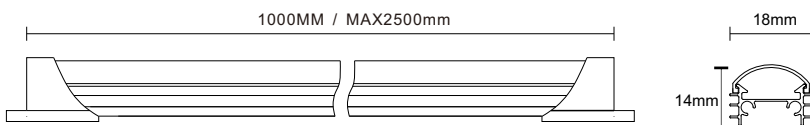

MINI size

Aluminum strip light



RAS-006-M1712

DC24V    **IP54** **CE** 

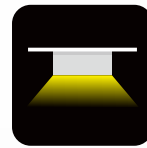

MODEL NO:RAS-006-M1712

POWER: 9.6W / 1M

Luminous flux: 1200LM/1M

Color temperature: 3000K & 4000K & 6000K

Color rendering index:RA>80

Input voltage: DC 24V

INGRESS PROTECTION:IP54



DIMENSION

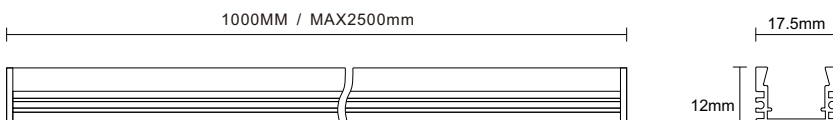

MINI size

Aluminum strip light

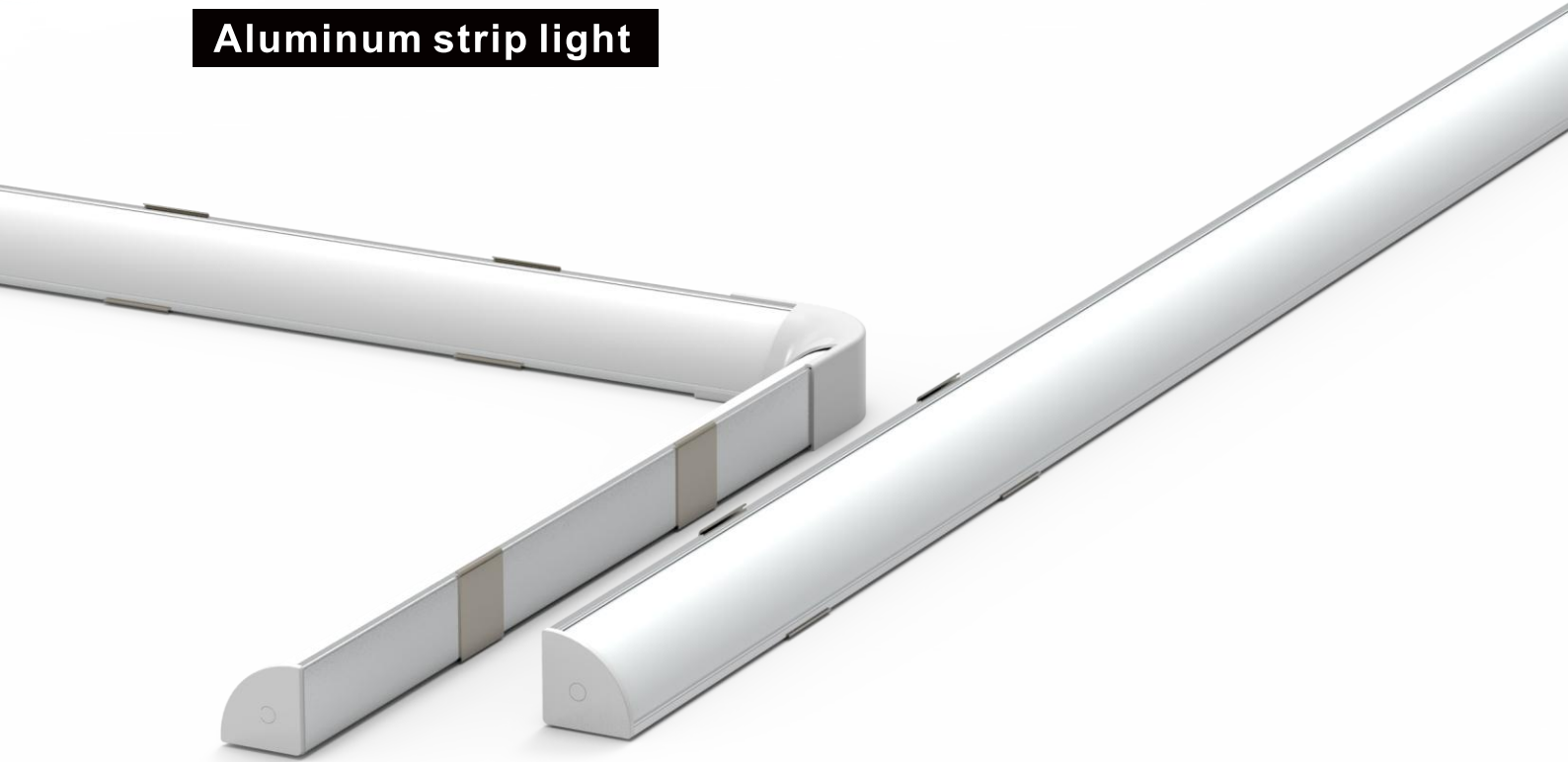

RAS-008-M1616

DC24V    **IP54** **CE** 



MODEL NO:RAS-008-M1616

POWER: 9.6W / 1M

Luminous flux: 1200LM/1M

Color temperature: 3000K & 4000K & 6000K

Color rendering index:RA>80

Input voltage: DC 24V

INGRESS PROTECTION:IP54

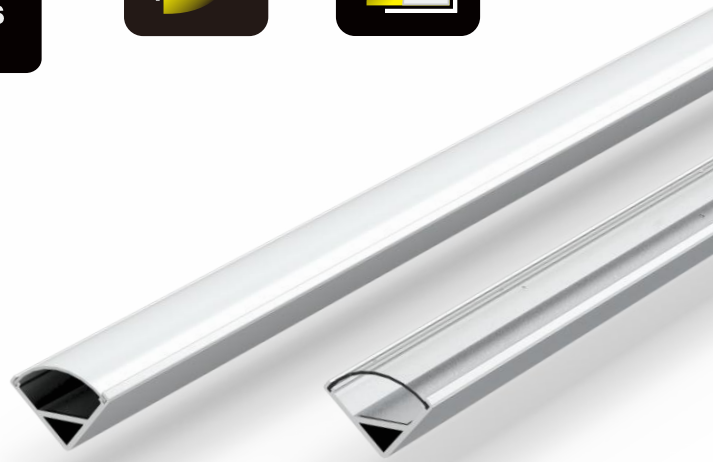

DIMENSION

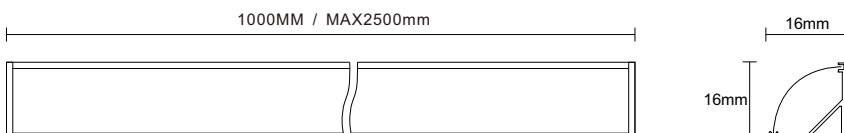

MINI size

Aluminum strip light



RAS-011-M1818

DC24V    **IP54** **CE** 



MODEL NO:RAS-011-M1818

POWER: 14.4W / 1M

Luminous flux: 1450LM/1M

Color temperature: 3000K & 4000K & 6000K

Color rendering index:RA>80

Input voltage: DC 24V

INGRESS PROTECTION:IP54



DIMENSION

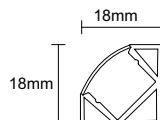
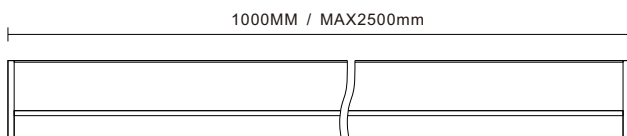

MINI size

Aluminum strip light



RAS-014-Y2407

DC24V    **IP54** **CE** 

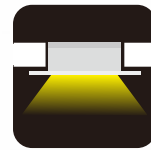

MODEL NO:RAS-014-Y2407

POWER: 9.6W / 1M

Luminous flux: 1200LM/1M

Color temperature: 3000K & 4000K & 6000K

Color rendering index:RA>80

Input voltage: DC 24V

INGRESS PROTECTION:IP54



DIMENSION

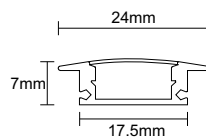
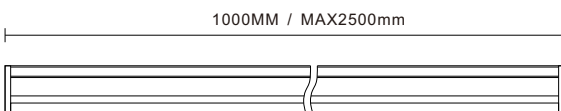

MINI size

Aluminum strip light

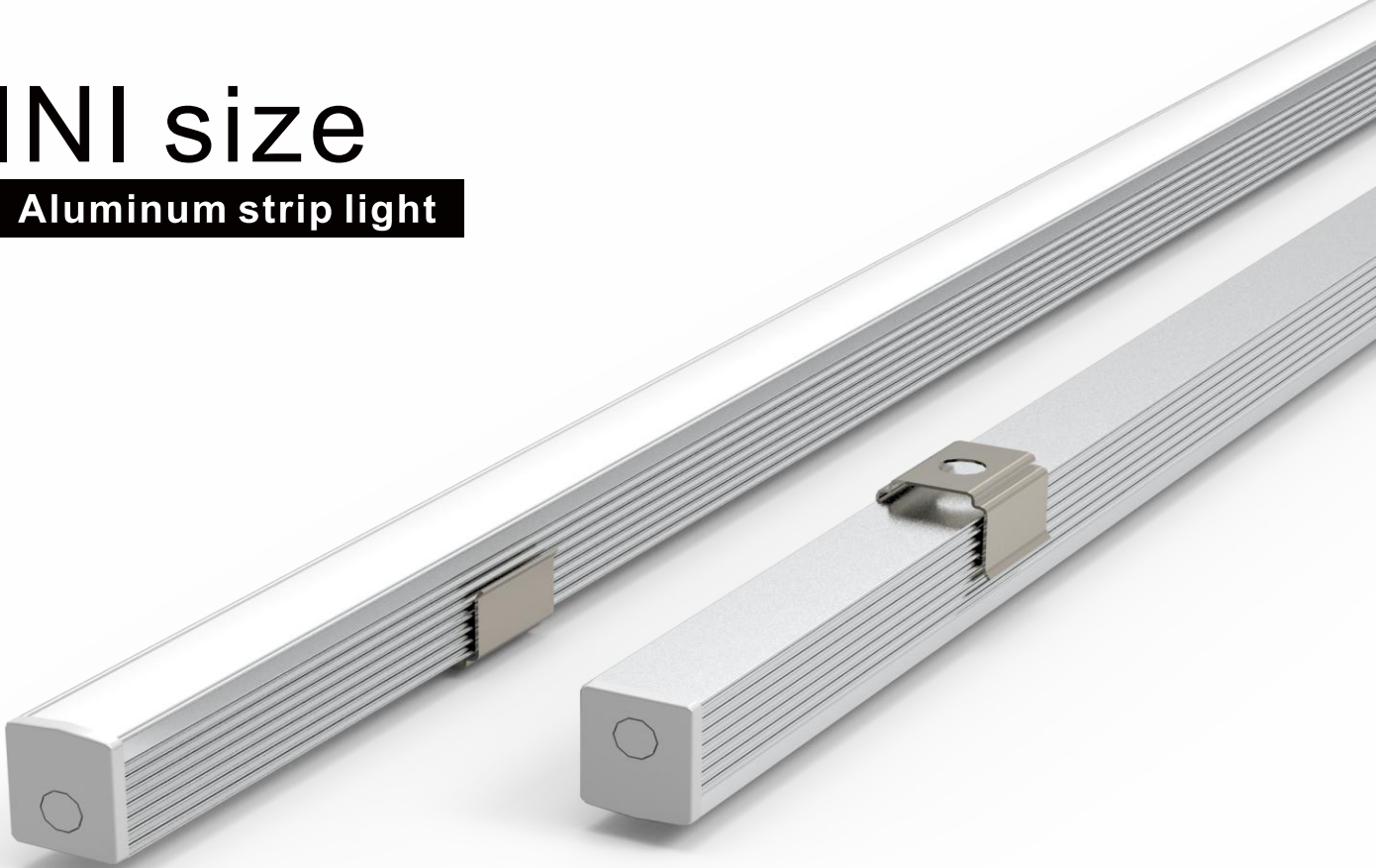

RAS-129-M0809

DC24V    **IP54** **CE** 



MODEL NO:RAS-129-M0809

POWER: 9.6W / 1M

Luminous flux: 1000LM/1M

Color temperature: 3000K & 4000K & 6000K

Color rendering index:RA>80

Input voltage: DC 24V

INGRESS PROTECTION:IP54

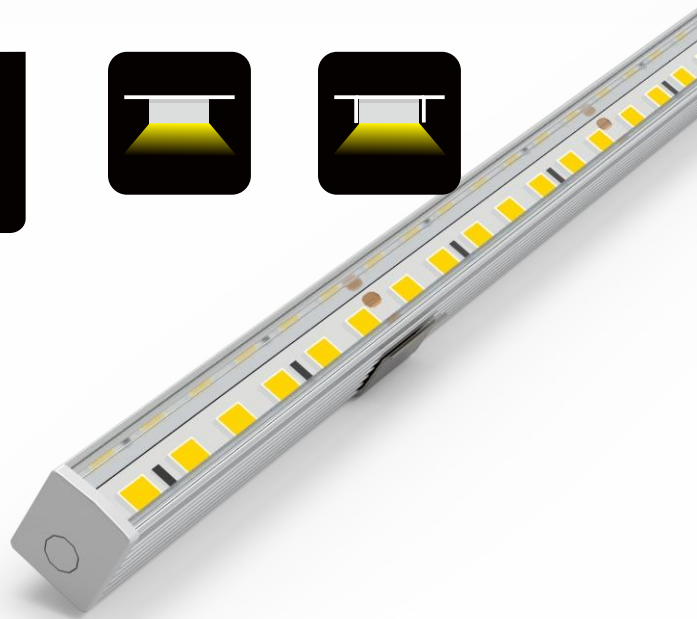

DIMENSION

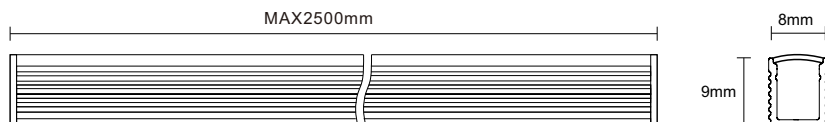

MINI size

Aluminum strip light



RAS-070-M2020

DC24V    **IP54**  



MODEL NO:RAS-070-M2020

POWER: 14.4W / 1M

Luminous flux: 1800LM/1M

Color temperature: 3000K & 4000K & 6000K

Color rendering index:RA>80

Input voltage: DC 24V

INGRESS PROTECTION:IP54



DIMENSION

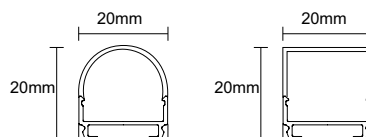
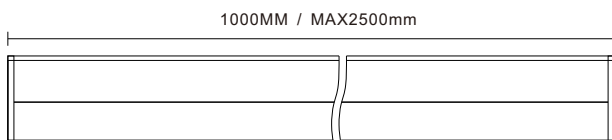

Middle size

Aluminum strip light



RAS-071-M2410/RAS-044-Y3110

DC24V    IP54 CE 



MODEL NO:RAS-071-M2410 RAS-044-Y3110

POWER: 14.4W / 1M

Luminous flux: 1600LM/1M

Color temperature: 3000K & 4000K & 6000K

Color rendering index:RA>80

Input voltage: DC 24V

INGRESS PROTECTION:IP54

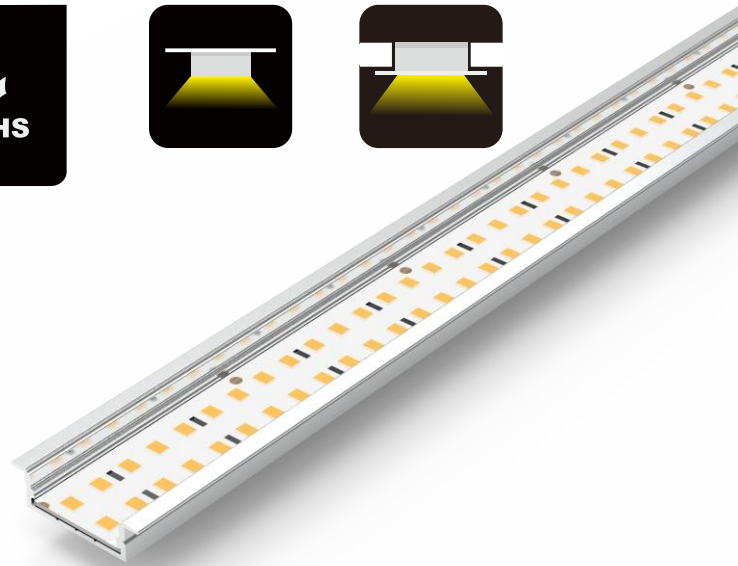

DIMENSION

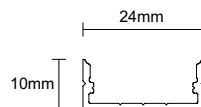
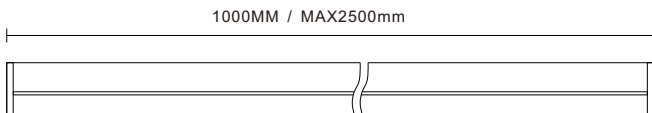

RAS-071-M2410

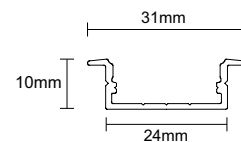

RAS-044-Y3110

Middle size

Aluminum strip light



RAS-180-Y4320

DC24V    **IP54**  

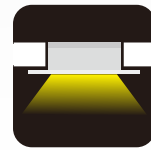

MODEL NO:RAS-180-Y4320

POWER: 19.5W / 1M

Luminous flux: 2400LM/1M

Color temperature: 3000K & 4000K & 6000K

Color rendering index:RA>80

Input voltage: DC 24V

INGRESS PROTECTION:IP54

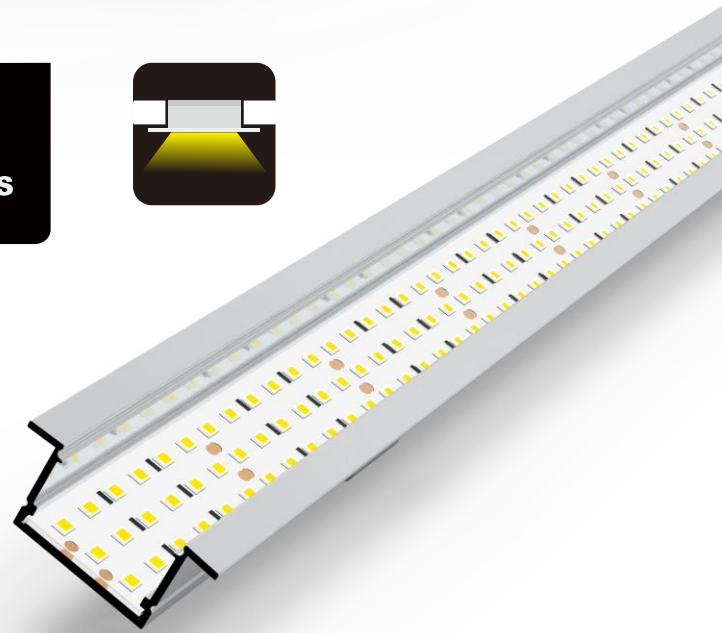

DIMENSION

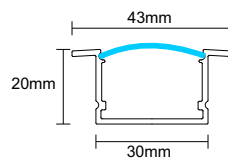
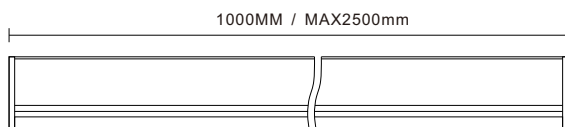

Middle size

Aluminum strip light



RAS-153-M3030

DC24V    **IP54** **CE** 



MODEL NO:RAS-153-M3030

POWER: 19.5W / 1M

Luminous flux: 2280LM/1M

Color temperature: 3000K & 4000K & 6000K

Color rendering index:RA>80

Input voltage: DC 24V

INGRESS PROTECTION:IP54



DIMENSION

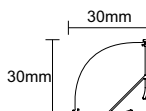
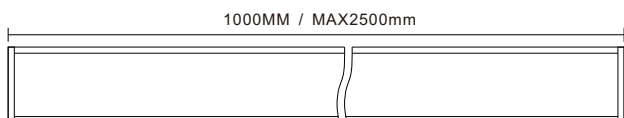

MAXIMUM size

Aluminum strip light



RAS-816-BM5050

240V



IP54



MODEL NO	POWER	P F	LUMEN OUTPUT	CCT	BEAM ANGLE	CRI	DIMMABLE
RAS-816-BM5050-15W	15W	0.9	1600	3000K/4000K/6000K	120°	≥80	Yes-triac
RAS-816-BM5050-20W	20W	0.9	2200	3000K/4000K/6000K	120°	≥80	Yes-triac
RAS-816-BM5050-30W	30W	0.9	3400	3000K/4000K/6000K	120°	≥80	Yes-triac

DIMENSIONS

MODEL NO	A(mm)	B(mm)	C(mm)
RAS-BLLS-6W	1000	50	50
RAS-BLLS-9W	1200	50	50
RAS-BLLS-18W	1500	50	50

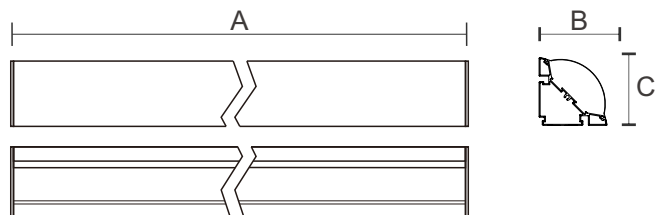

MAXIMUM size

Aluminum strip light

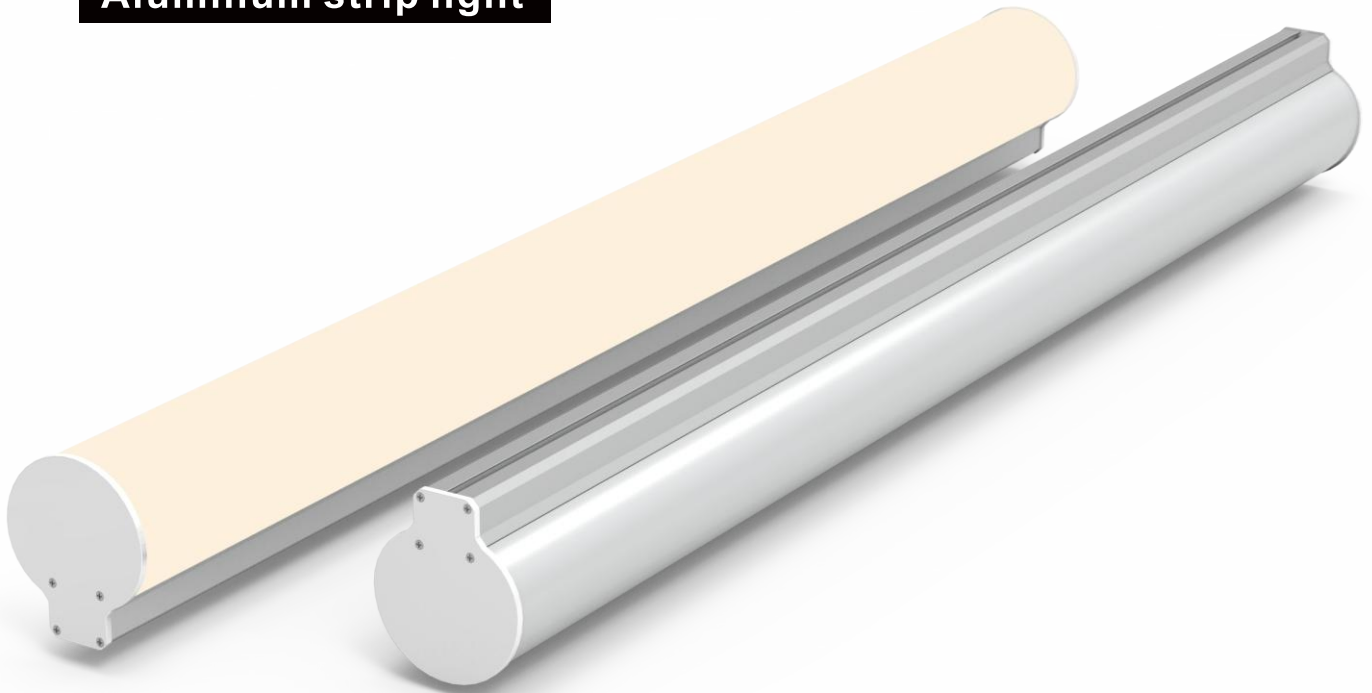

RAS-193-MB86100

240V



IP54



MODEL NO	POWER	P F	LUMEN OUTPUT	CCT	BEAM ANGLE	CRI	DIMMABLE
RAS-193-MB86100-30W	30W	0.9	3600	3000K/4000K/6000K	140°	≥80	Yes-triac
RAS-193-MB86100-40W	40W	0.9	4800	3000K/4000K/6000K	140°	≥80	Yes-triac
RAS-193-MB86100-50W	50W	0.9	5600	3000K/4000K/6000K	140°	≥80	Yes-triac

DIMENSIONS

MODEL NO	A(mm)	B(mm)	C(mm)
RAS-193-MB86100-30W	1000	86	100
RAS-193-MB86100-30W	1200	86	100
RAS-193-MB86100-30W	1500	86	100

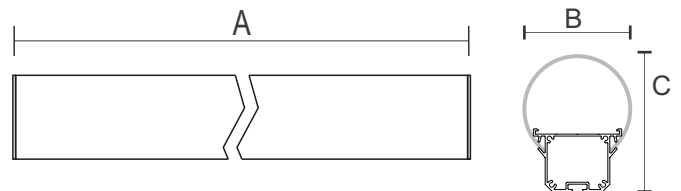

MAXIMUM size

Aluminum strip light

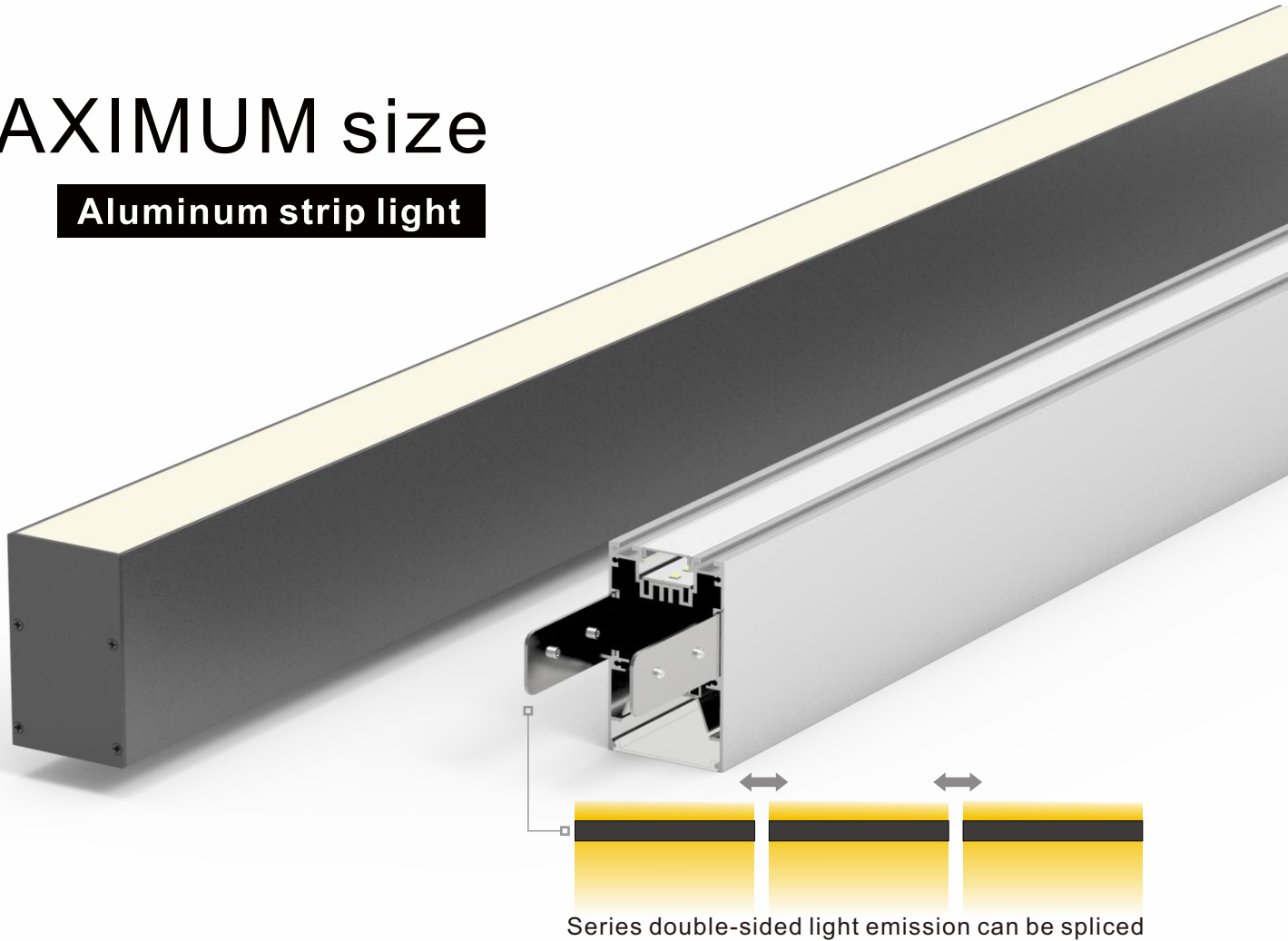

RAS-674-MB5090/RAS-675-MB7595

240V



IP54



MODEL NO	POWER	P F	LUMEN OUTPUT	CCT	BEAM ANGLE	CRI	DIMMABLE
RAS-674-MB5090-30W	30W	0.9	3400	3000K/4000K/6000K		≥80	Yes-triac
RAS-674-MB5090-40W	40W	0.9	4600	3000K/4000K/6000K		≥80	Yes-triac
RFR-674-MB5090-50W	50W	0.9	5750	3000K/4000K/6000K		≥80	Yes-triac
RAS-675-MB7595-40W	40W	0.9	4800	3000K/4000K/6000K		≥80	Yes-triac
RAS-674-MB7595-60W	60W	0.9	6800	3000K/4000K/6000K		≥80	Yes-triac
RFR-674-MB7595-80W	80W	0.9	9200	3000K/4000K/6000K		≥80	Yes-triac

DIMENSIONS

MODEL NO	A(mm)	B(mm)	C(mm)
RAS-674-MB5090-30W	1000	50	90
RAS-674-MB5090-40W	1200	50	90
RFR-674-MB5090-50W	1500	50	90
RAS-675-MB7595-40W	1000	75	90
RAS-675-MB7595-60W	1200	75	90
RFR-675-MB7595-80W	1500	75	90

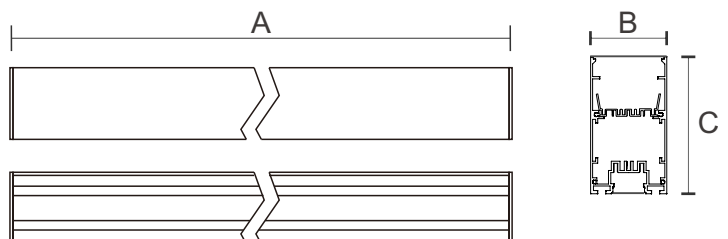

MAXIMUM size

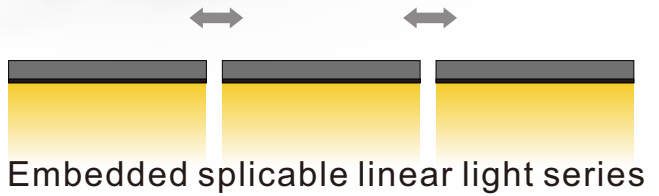

Aluminum strip light

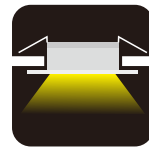

RAS-821-Y9535

240V    **IP54**  



MODEL NO	POWER	P F	LUMEN OUTPUT	CCT	BEAM ANGLE	CRI	DIMMABLE
RAS-821-Y9535-30W	30W	0.9	3600	3000K/4000K/6000K		≥80	Yes-triac
RAS-821-Y9535-40W	40W	0.9	4800	3000K/4000K/6000K		≥80	Yes-triac
RAS-821-Y9535-50W	50W	0.9	5800	3000K/4000K/6000K		≥80	Yes-triac

DIMENSIONS

MODEL NO	A(mm)	B(mm)	C(mm)
RAS-821-Y9535-20W	1000	95	35
RAS-821-Y9535-40W	1200	95	35
RAS-821-Y9535-50W	1500	95	35

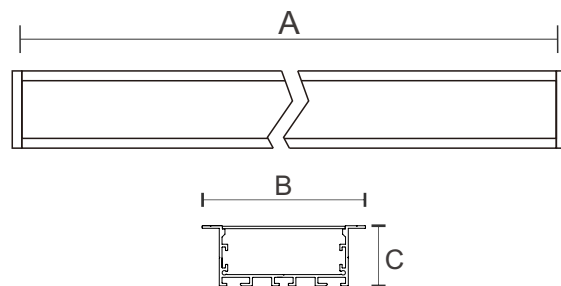

MAXIMUM size

Aluminum strip light

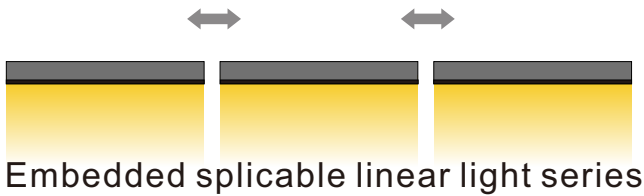
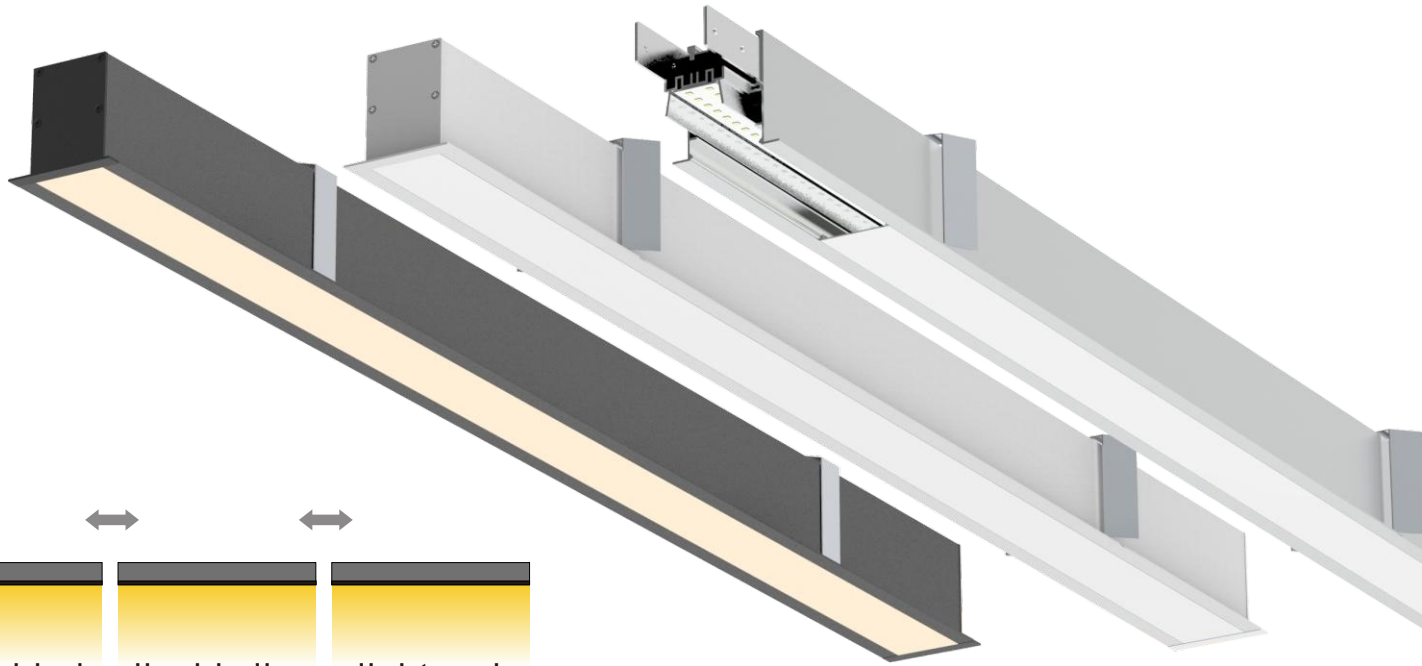

Embedded splicable linear light series

RAS-643-BY6875/BY9575/BY12075

240V



IP54



RoHS

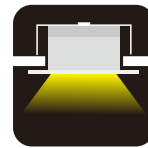

MODEL NO	POWER	P F	LUMEN OUTPUT	CCT	BEAM ANGLE	CRI	DIMMABLE
RAS-643-BY6875-30W	30W	0.9	3400	3000K/4000K/6000K	100°	≥80	Yes-triac
RAS-643-BY6875-40W	40W	0.9	4600	3000K/4000K/6000K	100°	≥80	Yes-triac
RFR-646-BY9575-40W	40W	0.9	4800	3000K/4000K/6000K	100°	≥80	Yes-triac
RAS-646-BY9575-50W	50W	0.9	5800	3000K/4000K/6000K	100°	≥80	Yes-triac
RAS-648-BY12075-60W	60W	0.9	6800	3000K/4000K/6000K	100°	≥80	Yes-triac
RFR-648-BY12075-80W	80W	0.9	9200	3000K/4000K/6000K	100°	≥80	Yes-triac

DIMENSIONS

MODEL NO	A(mm)	B(mm)	C(mm)	D(mm)
RAS-643-BY6875-30W	1200	68	75	50
RAS-643-BY6875-40W	1500	68	75	50
RFR-646-BY9575-40W	1200	95	75	75
RAS-646-BY9575-50W	1500	95	75	75
RAS-648-BY12075-60W	1200	120	75	100
RFR-648-BY12075-80W	1500	120	75	100

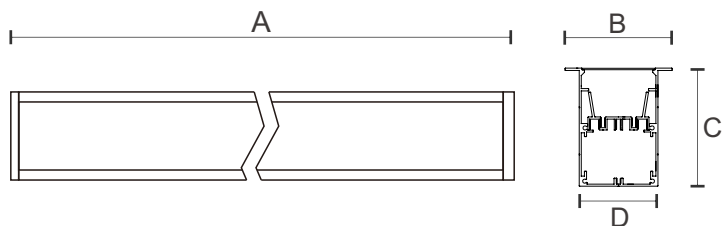

MAXIMUM size

Aluminum strip light

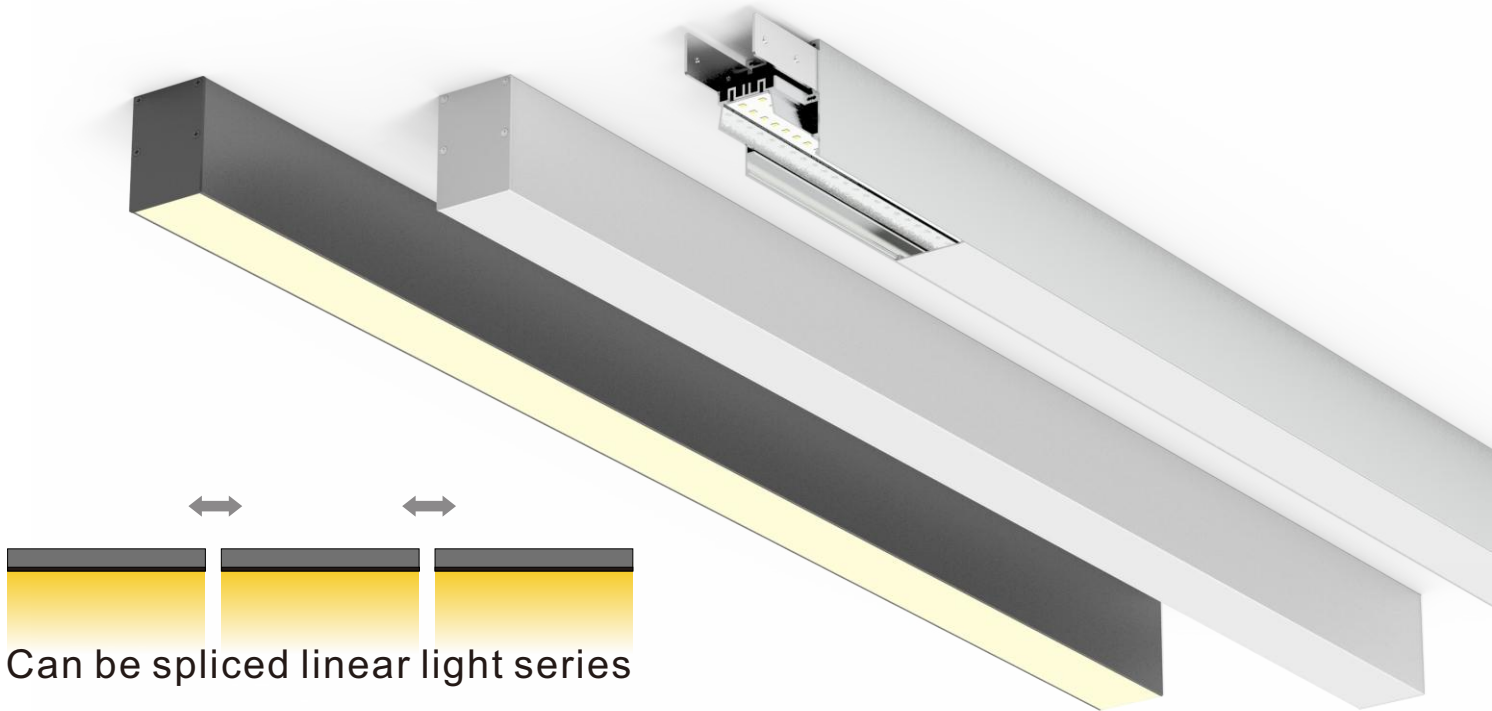

Can be spliced linear light series

RAS-644-BM5075/BM7575/BY10075

240V



IP54



RoHS



MODEL NO	POWER	P F	LUMEN OUTPUT	CCT	BEAM ANGLE	CRI	DIMMABLE
RAS-643-BM5075-30W	30W	0.9	3400	3000K/4000K/6000K		≥80	Yes-triac
RAS-643-BM5075-40W	40W	0.9	4600	3000K/4000K/6000K		≥80	Yes-triac
RFR-646-BM7575-40W	40W	0.9	4800	3000K/4000K/6000K		≥80	Yes-triac
RAS-646-BM7575-50W	50W	0.9	5800	3000K/4000K/6000K		≥80	Yes-triac
RAS-648-BM10075-60W	60W	0.9	6800	3000K/4000K/6000K		≥80	Yes-triac
RFR-648-BM10075-80W	80W	0.9	9200	3000K/4000K/6000K		≥80	Yes-triac

DIMENSIONS

MODEL NO	A(mm)	B(mm)	C(mm)
RAS-644-BM5075-30W	1200	50	75
RAS-644-BM5075-40W	1500	50	75
RFR-647-BM7575-40W	1200	75	75
RAS-647-BM7575-50W	1500	75	75
RAS-649-BM10075-60W	1200	100	75
RFR-649-BM10075-80W	1500	100	75

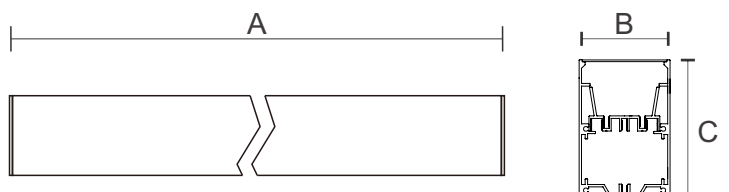

MAXIMUM size

Aluminum strip light





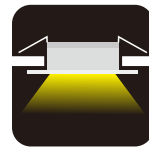

Embedded splicable linear light series

RAS-667-BM12035/BY16245

240V    IP54  



MODEL NO	POWER	P F	LUMEN OUTPUT	CCT	BEAM ANGLE	CRI	DIMMABLE
RAS-667-BM12035-40W	40W	0.9	4800	3000K/4000K/6000K		≥80	Yes-triac
RAS-667-BM12035-60W	60W	0.9	6600	3000K/4000K/6000K		≥80	Yes-triac
RFR-681-BY16245-80W	80W	0.9	8800	3000K/4000K/6000K		≥80	Yes-triac
RAS-681-BY16245-100W	100W	0.9	11500	3000K/4000K/6000K		≥80	Yes-triac

DIMENSIONS

MODEL NO	A(mm)	B(mm)	C(mm)	D(mm)
RAS-667-BY12035-40W	1200	120	35	100
RAS-667-BY12035-60W	1500	120	35	100
RFR-681-BY16245-80W	1200	162	45	150
RAS-681-BY16245-100W	1500	162	45	150

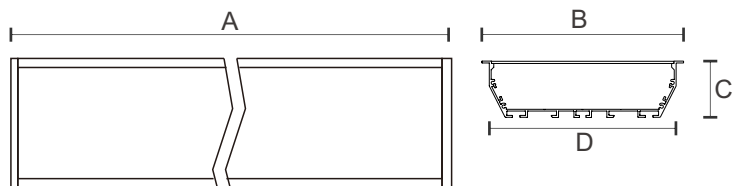

Regional optical Aluminum strip



Regional optical

Aluminum strip light



BEAM ANGLE

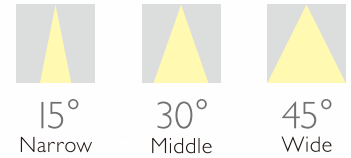

RAS-184-BM2427

240V



IP54

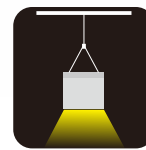

MODEL NO	POWER	P F	LUMEN OUTPUT	CCT	BEAM ANGLE	CRI	DIMMABLE
RAS-184-BM2427-10W	10W	0.9	800	3000K/4000K/6000K		≥80	Yes-triac
RAS-184-BM2427-15W	15W	0.9	1200	3000K/4000K/6000K		≥80	Yes-triac
RAS-184-BM2427-20W	20W	0.9	1700	3000K/4000K/6000K		≥80	Yes-triac

DIMENSIONS

MODEL NO	A(mm)	B(mm)	C(mm)
RAS-184-BM2427-10W	1000	24	27
RAS-184-BM2427-15W	1200	24	27
RAS-184-BM2427-20W	1500	24	27

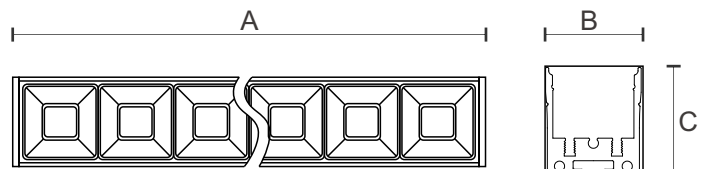

Regional optical

Aluminum strip light

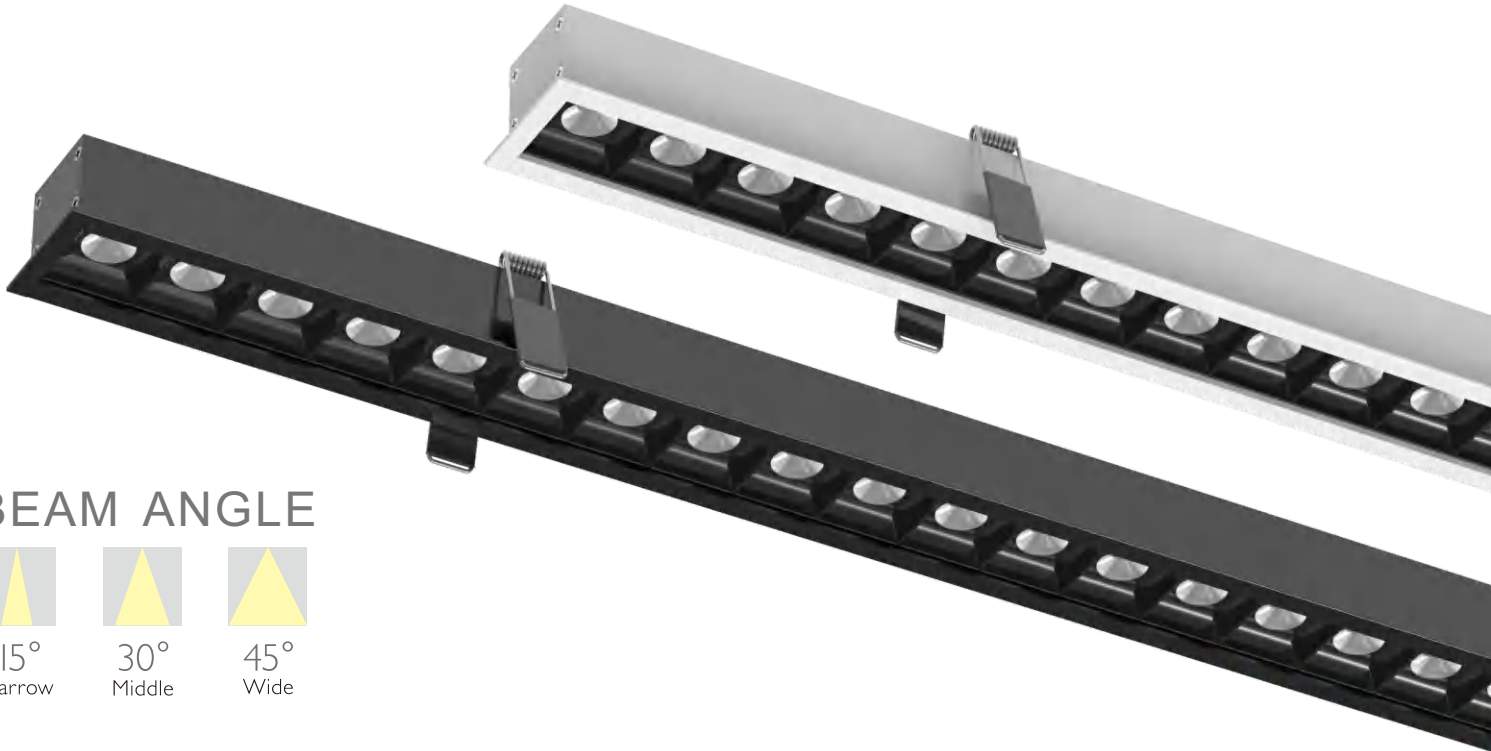



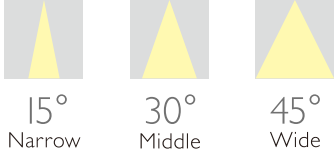





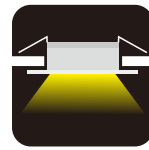

BEAM ANGLE



RAS-682-BY4633

240V    IP54  



MODEL NO	POWER	P F	LUMEN OUTPUT	CCT	BEAM ANGLE	CRI	DIMMABLE
RAS-682-BY4633-20W	20W	0.9	1600	3000K/4000K/6000K	  	≥80	Yes-triac
RAS-682-BY4633-30W	30W	0.9	2800	3000K/4000K/6000K	  	≥80	Yes-triac
RAS-682-BY4633-40W	40W	0.9	3600	3000K/4000K/6000K	  	≥80	Yes-triac

DIMENSIONS

MODEL NO	A(mm)	B(mm)	C(mm)
RAS-682-BY4633-20W	1000	46	33
RAS-682-BY4633-30W	1200	46	33
RAS-682-BY4633-40W	1500	46	33

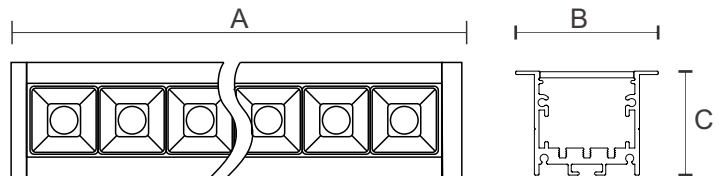

Regional optical

Aluminum strip light

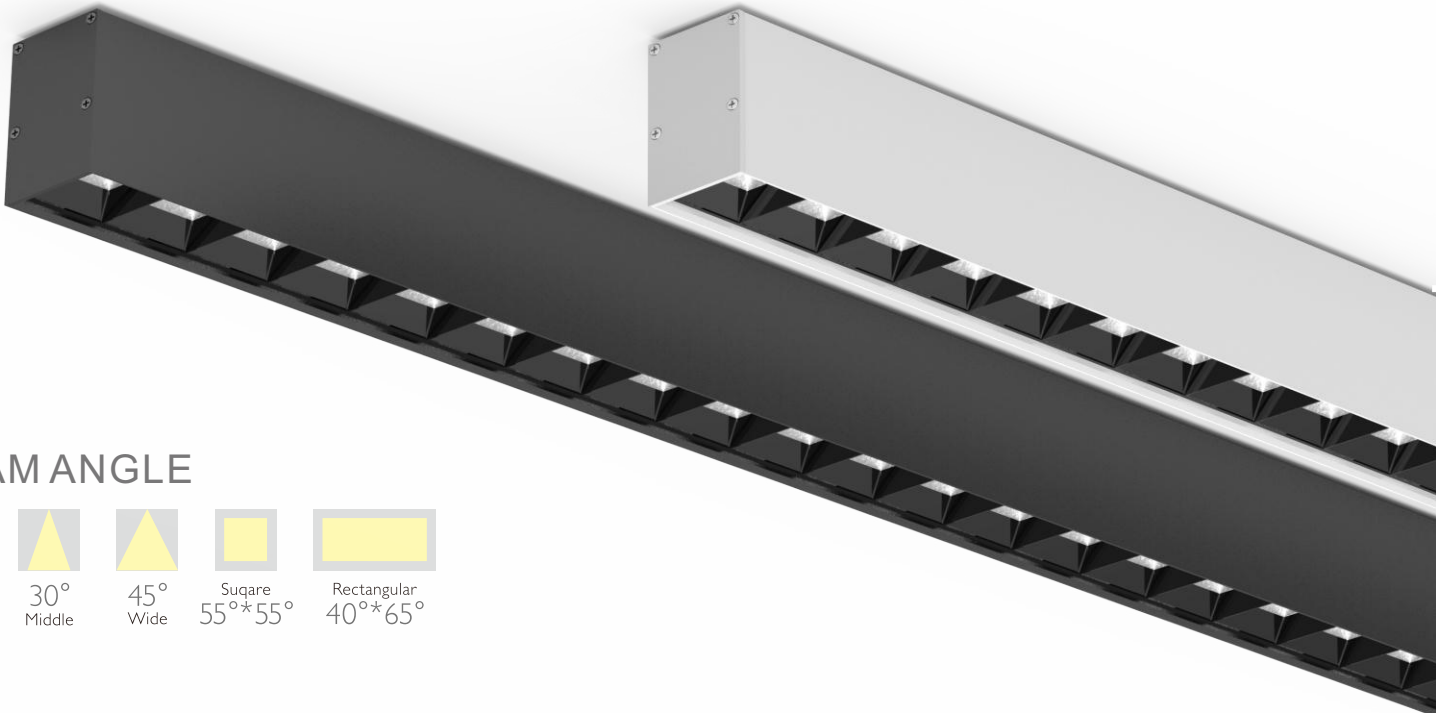



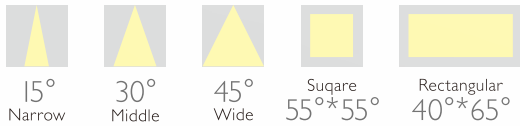











BEAM ANGLE



RAS-836-BM4375

240V    **IP54**  



MODEL NO	POWER	P F	LUMEN OUTPUT	CCT	BEAM ANGLE	CRI	DIMMABLE
RAS-836-BM4375-30W	30W	0.9	2600	3000K/4000K/6000K	    	≥80	Yes-triac
RAS-836-BM4375-40W	40W	0.9	3600	3000K/4000K/6000K	    	≥80	Yes-triac
RAS-836-BM4375-50W	50W	0.9	4500	3000K/4000K/6000K	    	≥80	Yes-triac

DIMENSIONS

MODEL NO	A(mm)	B(mm)	C(mm)
RAS-682-BM4375-30W	1000	80	55
RAS-682-BM4375-40W	1200	90	60
RAS-682-BM4375-50W	1500	90	75

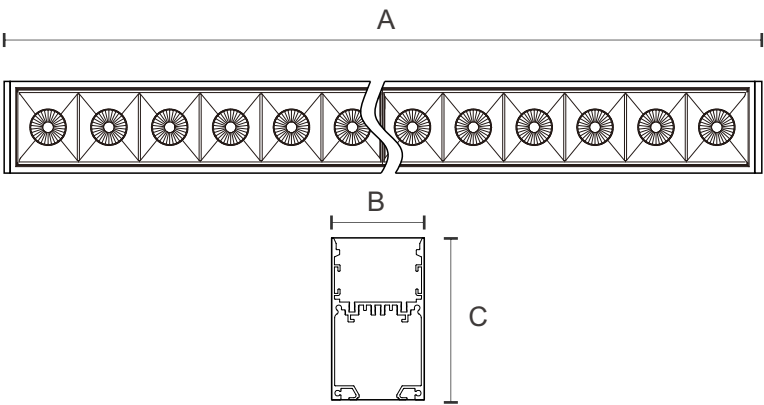

Regional optical aluminum strip



Regional optical

Aluminum strip light

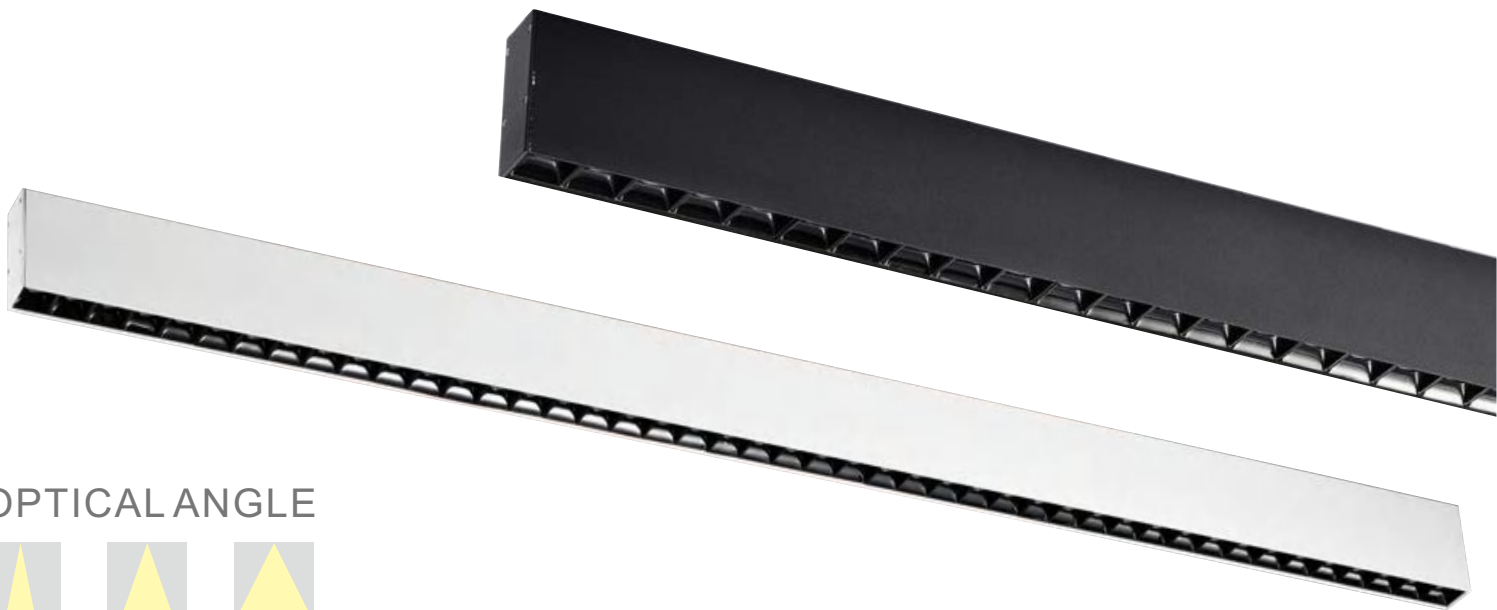

OPTICAL ANGLE



15° Narrow 30° Middle 45° Wide

RAS-A825-BM3370

240V



IP54



RoHS



MODEL NO	POWER	P F	LUMEN OUTPUT	CCT	BEAM ANGLE	CRI	DIMMABLE
RAS-A825-BM3370-30W	30W	0.9	3200	3000K/4000K/6000K		≥80	Yes-triac
RAS-A825-BM3370-50W	50W	0.9	5200	3000K/4000K/6000K		≥80	Yes-triac
RAS-A825-BM3370-60W	60W	0.9	6200	3000K/4000K/6000K		≥80	Yes-triac

DIMENSIONS

MODEL NO	A(mm)	B(mm)	C(mm)
RAS-A825-BM3370-30W	1000	33	70
RAS-A825-BM3370-50W	1200	33	70
RAS-A825-BM3370-60W	1500	33	70

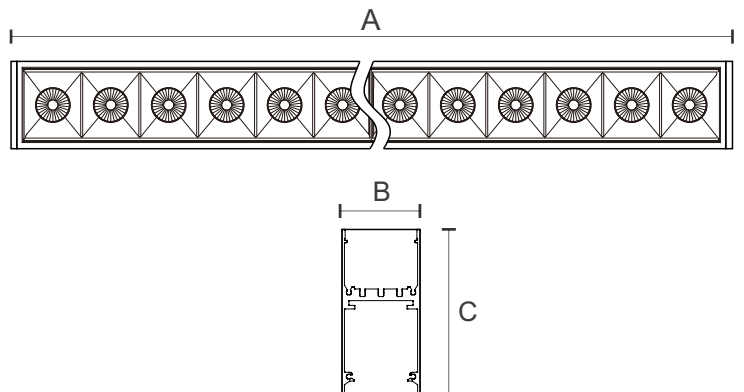

Regional optical

Aluminum strip light

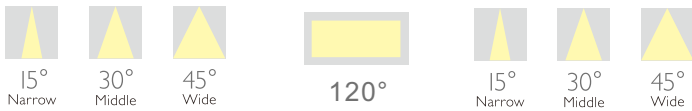

RAS-B825-BM3370

240V



IP54

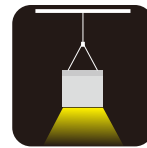

MODEL NO	POWER	P F	LUMEN OUTPUT	CCT	BEAM ANGLE	CRI	DIMMABLE
RAS-B825-BM3370-30W	30W	0.9	3600	3000K/4000K/6000K	10° 30° 45° + 120°	≥80	Yes-triac
RAS-B825-BM3370-50W	50W	0.9	5500	3000K/4000K/6000K	10° 30° 45° + 120°	≥80	Yes-triac
RAS-B825-BM3370-60W	60W	0.9	6600	3000K/4000K/6000K	10° 30° 45° + 120°	≥80	Yes-triac

DIMENSIONS

MODEL NO	A(mm)	B(mm)	C(mm)
RAS-B825-BM3370-30W	1000	33	70
RAS-B825-BM3370-50W	1200	33	70
RAS-B825-BM3370-60W	1500	33	70

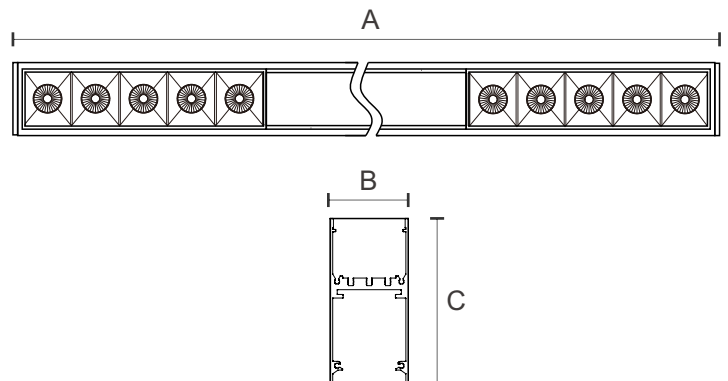

Regional optical

Aluminum strip light



BEAM ANGLE



15° Narrow 30° Middle 45° Wide

RAS-A827-BM5580

240V



IP54

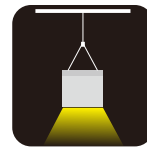

MODEL NO	POWER	P F	LUMEN OUTPUT	CCT	BEAM ANGLE	CRI	DIMMABLE
RAS-A827-BM5580-40W	40W	0.9	4300	3000K/4000K/6000K		≥80	Yes-triac
RAS-A827-BM5580-60W	60W	0.9	6400	3000K/4000K/6000K		≥80	Yes-triac
RAS-A827-BM5580-72W	72W	0.9	7500	3000K/4000K/6000K		≥80	Yes-triac

DIMENSIONS

MODEL NO	A(mm)	B(mm)	C(mm)
RAS-A827-BM5580-40W	1000	55	80
RAS-A827-BM5580-60W	1200	55	80
RAS-A827-BM5580-72W	1500	55	80

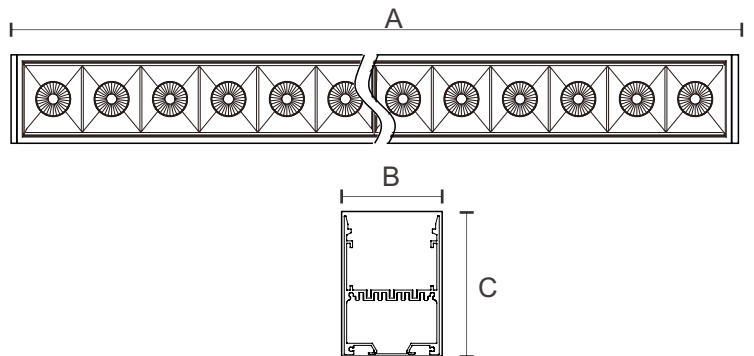





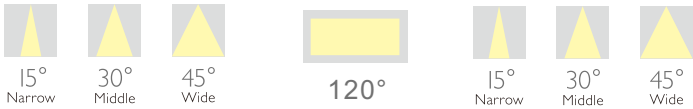

Regional optical













Aluminum strip light



RAS-B827-BM5580

240V    **IP54**  



MODEL NO	POWER	P F	LUMEN OUTPUT	CCT	BEAM ANGLE	CRI	DIMMABLE
RAS-A827-BM5580-40W	40W	0.9	4300	3000K/4000K/6000K	   + 	≥80	Yes-triac
RAS-A827-BM5580-60W	60W	0.9	6400	3000K/4000K/6000K	   + 	≥80	Yes-triac
RAS-A827-BM5580-72W	72W	0.9	7500	3000K/4000K/6000K	   + 	≥80	Yes-triac

DIMENSIONS

MODEL NO	A(mm)	B(mm)	C(mm)
RAS-B827-BM5580-40W	1000	55	80
RAS-B827-BM5580-60W	1200	55	80
RAS-B827-BM5580-72W	1500	55	80

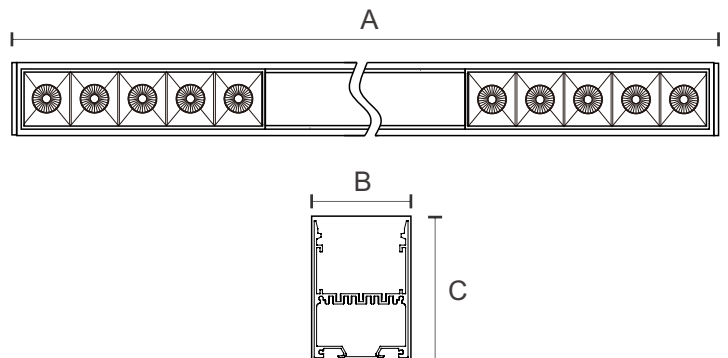

WALLWASHER

Aluminum strip light

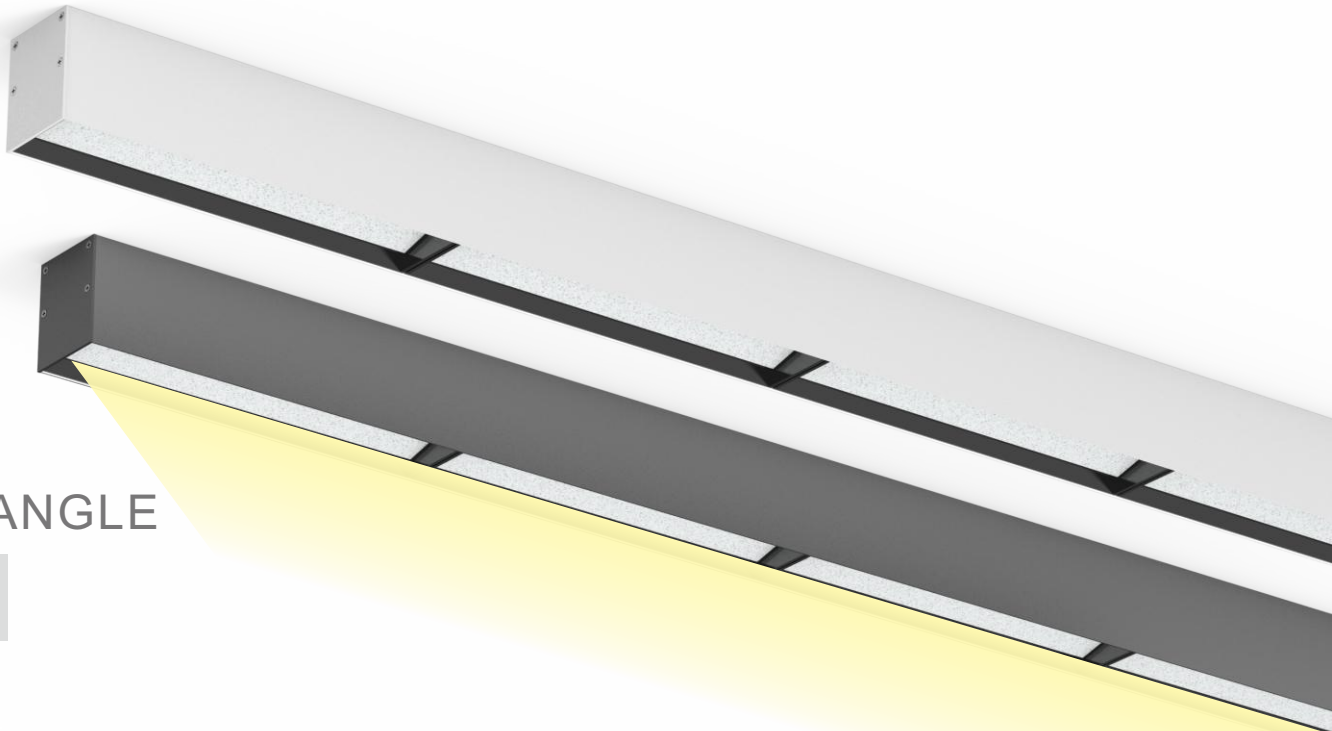



BEAM ANGLE



RAS-688-BM5575

240V    IP54  



MODEL NO	POWER	P F	LUMEN OUTPUT	CCT	BEAM ANGLE	CRI	DIMMABLE
RAS-688-BM5575-30W	30W	0.9	2900	3000K/4000K/6000K		≥80	Yes-triac
RAS-688-BM5575-40W	40W	0.9	4100	3000K/4000K/6000K		≥80	Yes-triac
RAS-688-BM5575-60W	60W	0.9	6200	3000K/4000K/6000K		≥80	Yes-triac

DIMENSIONS

MODEL NO	A(mm)	B(mm)	C(mm)
RAS-688-BM5575-30W	930	55	75
RAS-688-BM5575-40W	1130	55	75
RAS-688-BM5575-60W	1430	55	75

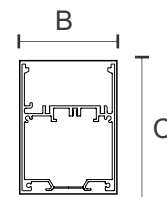
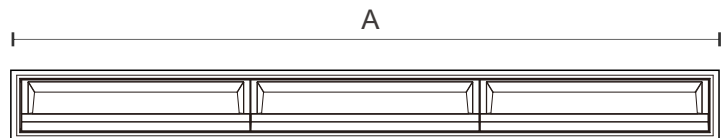

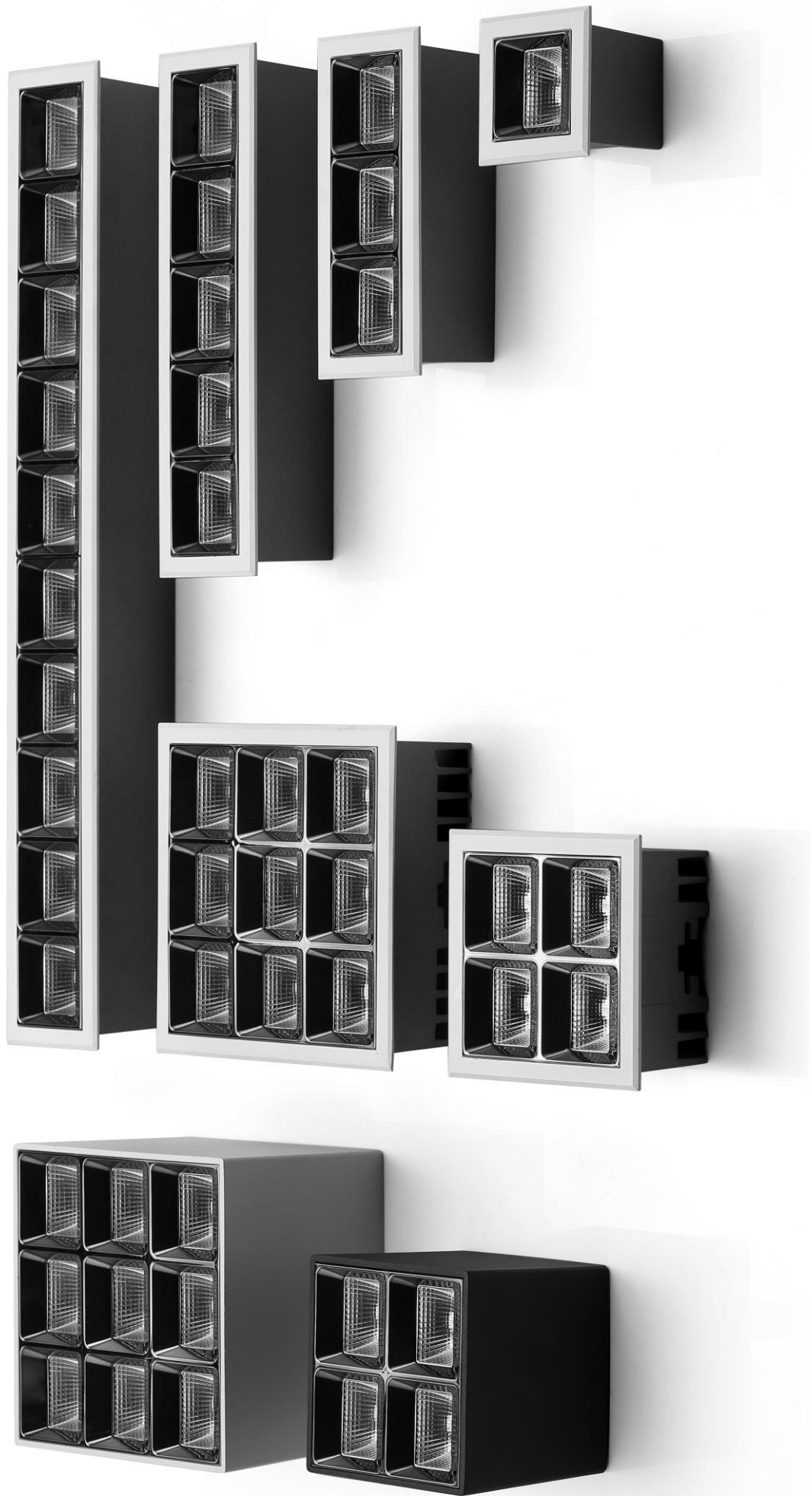

EMBEDDED MINI

Linear Light Series



1 LED | 3W



3 LED | 6W

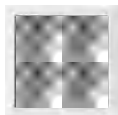

4 LED | 10W



5 LED | 12W

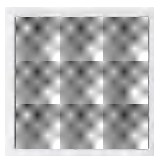

9 LED | 18W



10 LED | 24W



1 LED | 3W



3 LED | 6W



4 LED | 10W



5 LED | 12W



9 LED | 18W



10 LED | 24W

BEAM ANGLE

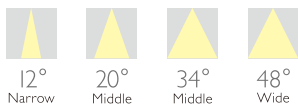

12° Narrow 20° Middle 34° Middle 48° Wide

BEAM ANGLE



Square 55°*55°

EMBEDDED MINI

Linear Light Series



1 LED | 3W



3 LED | 6W



4 LED | 10W



5 LED | 12W

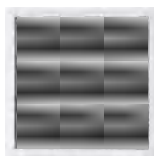

9 LED | 18W



10 LED | 24W



1 LED | 3W



3 LED | 6W

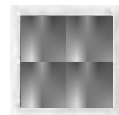

4 LED | 10W



5 LED | 12W

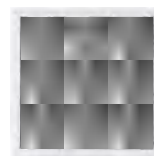

9 LED | 18W



10 LED | 24W

BEAM ANGLE

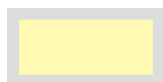

Rectangular 40°*65°

BEAM ANGLE



Flood 60°

EMBEDDED MINI

Linear Light Series



1 LED | 3W

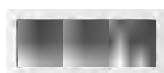

3 LED | 6W

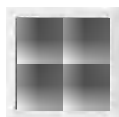

4 LED | 10W



5 LED | 12W

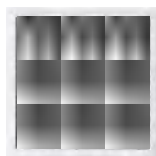

9 LED | 18W



10 LED | 24W



1 LED | 3W



3 LED | 6W

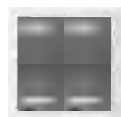

4 LED | 10W



5 LED | 12W

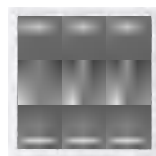

9 LED | 18W



10 LED | 24W

BEAM ANGLE



Flood 40°

BEAM ANGLE



Wallwasher

EMBEDDED MINI

Linear Light Series

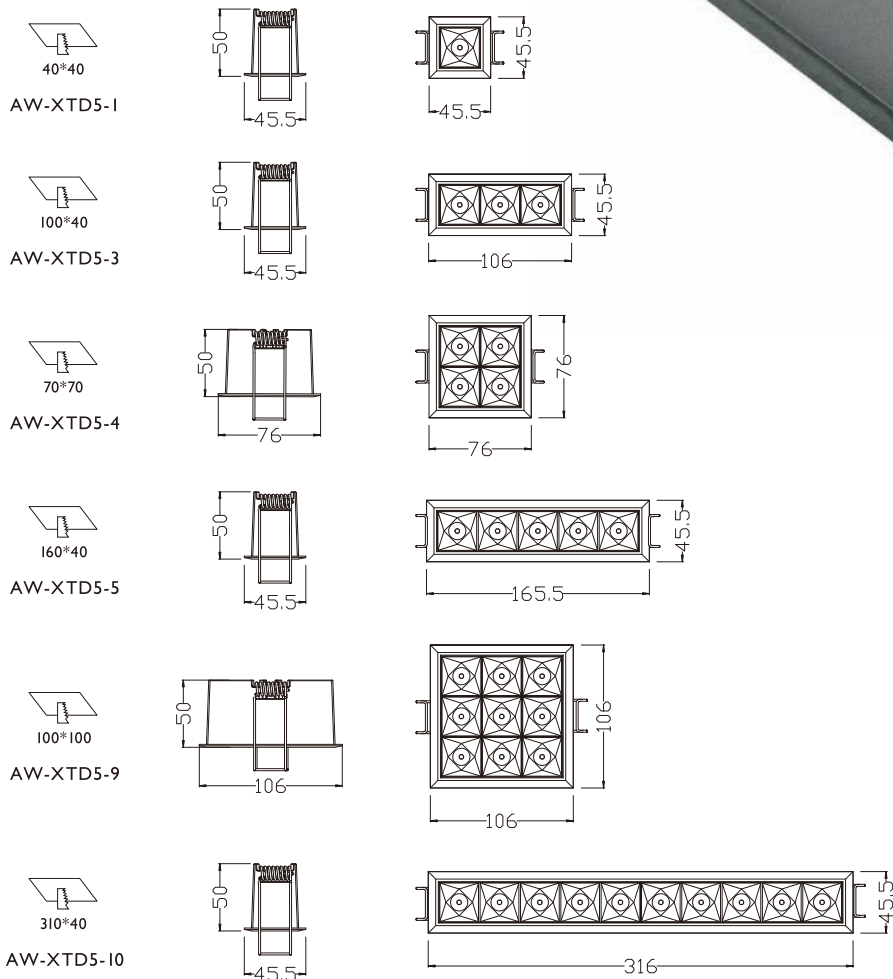
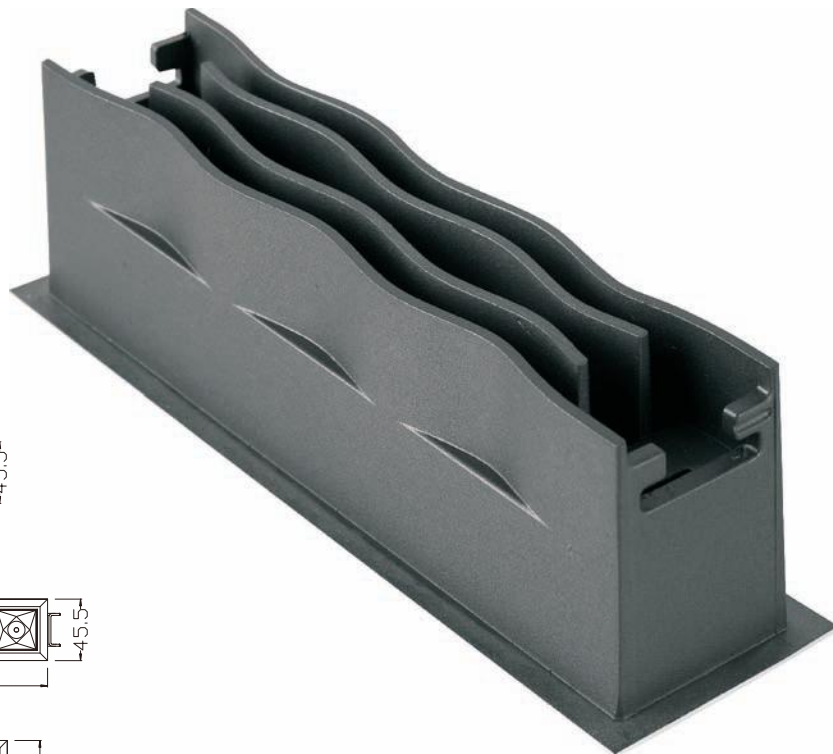

EMBEDDED MINI

Linear Light Series

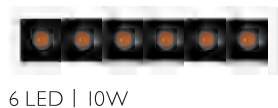

BEAM ANGLE



30°



60°



30°*30°

EMBEDDED MINI

Linear Light Series



48*27.5
AW-XTD3-2

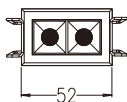
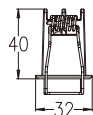

57*27.5
AW-XTD3-3

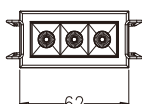
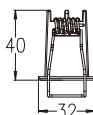

48*48
AW-XTD3-4

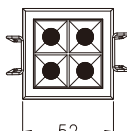
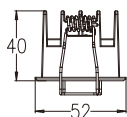

104*27.5
AW-XTD3-5

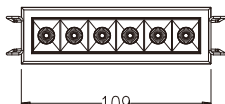
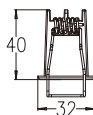

68*68
AW-XTD3-9

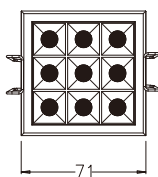
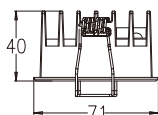

200*27.5
AW-XTD3-12

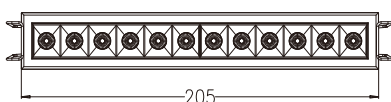
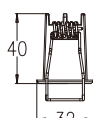

EMBEDDED MINI

Linear Light Series



1 LED | 5W



3 LED | 12W



4 LED | 15W



5 LED | 20W



9 LED | 36W



10 LED | 40W



1 LED | 5W



3 LED | 12W



4 LED | 15W



5 LED | 20W



9 LED | 36W



10 LED | 40W

BEAM ANGLE



12°
Narrow



23°
Middle



38°
Middle



50°
Wide

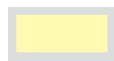

Rectangular
24°*77°

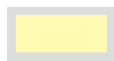

Rectangular
38°*77°



Wallwasher

EMBEDDED MINI

Linear Light Series

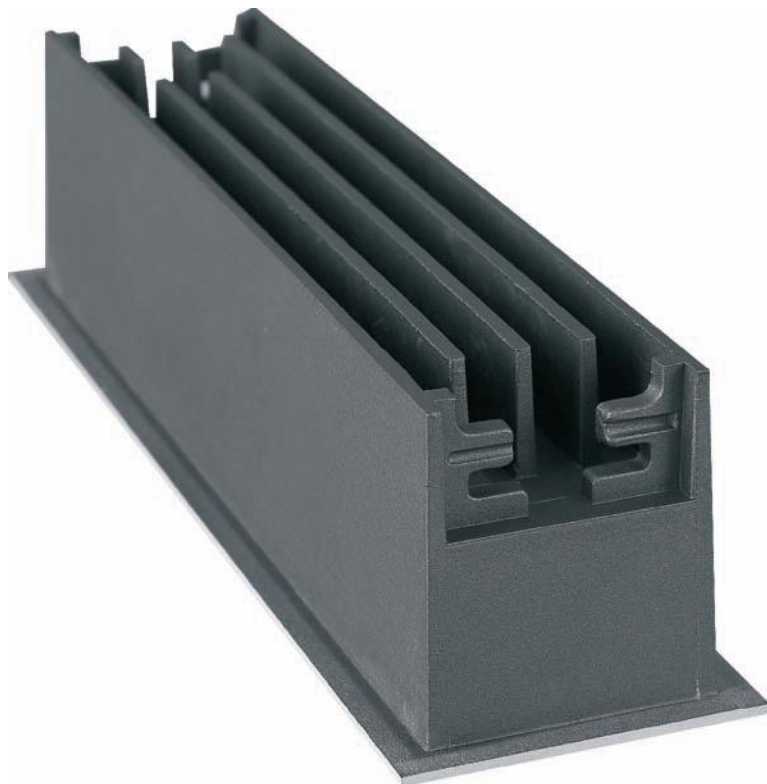

49*49
AW-XTD2-1

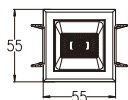

AW-XTD2-3

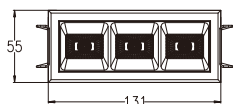

AW-XTD2-4

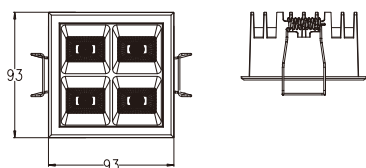

AW-XTD2-5

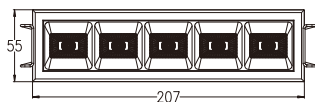

AW-XTD2-9

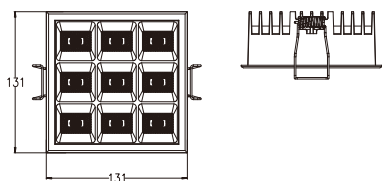

AW-XTD2-10

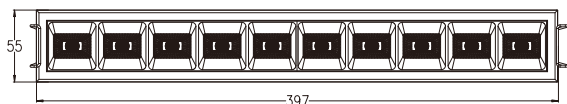

EMBEDDED MINI

Linear Light Series



1 LED | 2W



AW-XTD-A-01



2 LED | 4W



AW-XTD-A-02

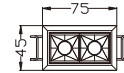

5 LED | 10W



AW-XTD-A-05

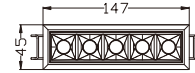

10 LED | 20W



AW-XTD-A-10

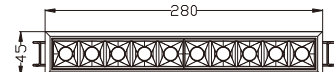

15 LED | 30W



AW-XTD-A-15

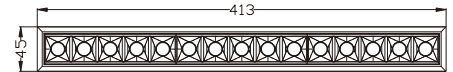

BEAM ANGLE



15°
Narrow



30°
Middle



45°
Wide



Square
55°*55°

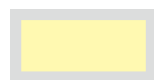

Rectangular
40°*65°

LIGHT EFFECT

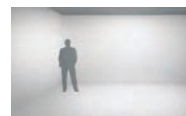

General Lighting



Accent Lighting



Wall washing Lighting

EMBEDDED MINI

Linear Light Series

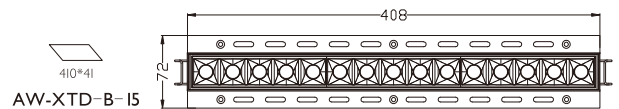
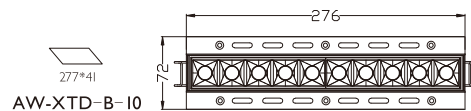
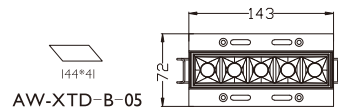
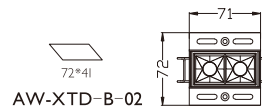
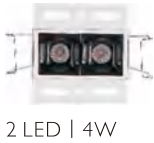
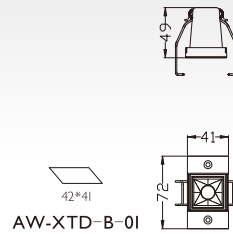

BEAM ANGLE



15°
Narrow



30°
Middle



45°
Wide



Square
55°*55°

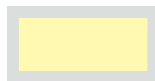

Rectangular
40°*65°

EMBEDDED MINI

Linear Light Series



5 LED | 10W



10 LED | 20W



15 LED | 30W



AW-XTD-WW-05

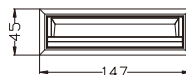

AW-XTD-WW-10

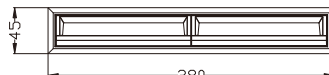

AW-XTD-WW-15



BEAM ANGLE



Wallwasher

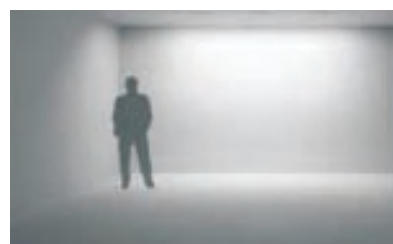

Wall washing Lighting

EMBEDDED MINI

Linear Light Series



10 LED | 10W



20 LED | 20W



30 LED | 30W



AW-XTD-XZ-05

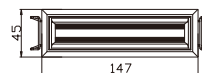

AW-XTD-XZ-10

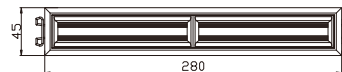

AW-XTD-XZ-15

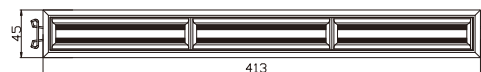

BEAM ANGLE



Flood 60°

EMBEDDED MINI

Linear Light Series



1 LED | 10W

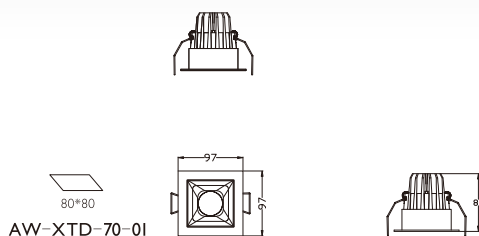

2 LED | 20W

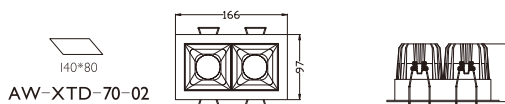

3 LED | 30W

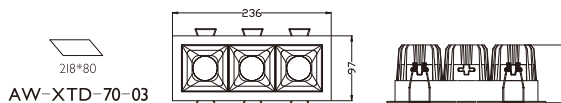

BEAM ANGLE



15°
Narrow



30°
Middle



45°
Wide

EMBEDDED MINI

Linear Light Series



10 LED | 20W



15 LED | 30W



10x2 LED | 40W



15x2 LED | 60W



AW-GSD 10-1

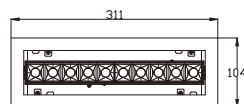

AW-GSD 15-1

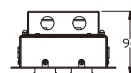
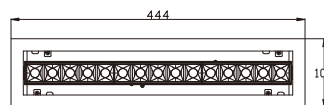

AW-GSD 10-2

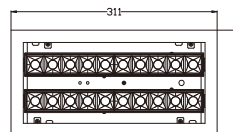

AW-GSD 15-2

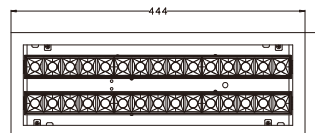

BEAM ANGLE



15°
Narrow



30°
Middle



45°
Wide



Square
55°*55°

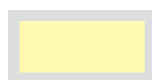

Rectangular
40°*65°

CEILING

SQUARE SERIES

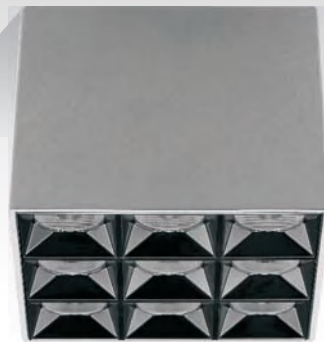

4 LED | 15W



4 LED | 15W

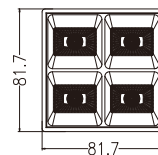

AW-MD006-4

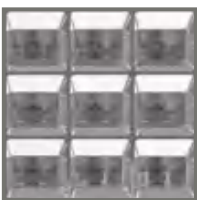
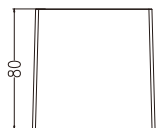

9 LED | 36W



9 LED | 36W

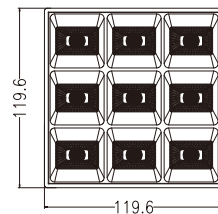

AW-MD006-9



BEAM ANGLE

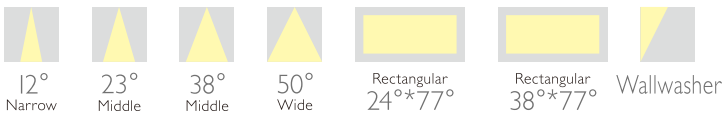

12°
Narrow

23°
Middle

38°
Middle

50°
Wide

Rectangular
24°x77°

Rectangular
38°x77°

Wallwasher

CEILING

SQUARE SERIES

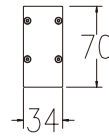

10 LED | 10W



20 LED | 20W



30 LED | 30W

AW-XTD3470-05



AW-XTD3470-10



AW-XTD3470-15



BEAM ANGLE



15°
Narrow



30°
Middle



45°
Wide



Square
55°*55°

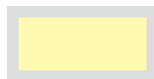

Rectangular
40°*65°

